

Electrorad Digi-Line

Installation, Operating & Instruction Manual



DigiLine



Class I - 230V - 50 Hz

Contents

1.0	Warnings & Safety Information	03
2.0	General Information	05
3.0	Installation	06
4.0	Maintenance, Repair & Disposal	07
5.0	Waste Disposal According to The WEEE Directive (2012/19/EU)	08
6.0	Warranty	08
7.0	Operating Instructions	08
7.1	Display	08
7.2	Behaviour Indicator	09
7.3	Keypad	09
8.0	Working Mode Definition	09
8.1	Heating	10
8.2	Advanced Mode	10
8.3	Stand Alone Radiator	10
8.4	Radiator Connected to a Unisenza Plus Gateway	11
8.5	Key Lock Function	11
9.0	Parameter Menu	12
10.0	Technical Characteristics	19
11.0	Troubleshooting & Solution	20
12.0	Preset Programmes	21
13.0	Eco Directive Characteristics	22

1.0 Warnings & Safety Information

SAFETY INFORMATION

This appliance can be used by children aged from 8 years and above and persons with reduced physical, sensory or mental capabilities or lack of experience and knowledge, if they have been given supervision or instruction concerning use of the appliance in a safe way and understand the hazards involved.

Children shall not play with the appliance.

Cleaning and user maintenance shall not be made by children unless they are older than 8 and supervised.

Keep the appliance and its cord out of reach of children aged less than 8 years.

Children of less than 3 years should be kept away from the unit unless continuously supervised.

Children aged from 3 years and less than 8 years shall only switch on/off the appliance provided that it has been placed or installed in its normal operating position and they have been given supervision or instruction concerning use of the appliance in a safe way and understand the hazards involved.

Children aged from 3 years and less than 8 years shall not plug in, regulate, clean the appliance or perform user maintenance.

1.0 Warnings & Safety Information (cont...)

CAUTION

Some parts of this product can become very hot and cause burns. Particular attention has to be given where children and vulnerable people are present.



In order to avoid overheating, do not cover the radiator. "Do not cover" means that the radiator must not be used for drying clothes, for example, by placing them directly on the radiator.



IMPORTANT SAFETY INSTRUCTIONS!

Before starting work disconnect power supply!

All installation work and wiring work related to the radiators, thermostats and programmers must be carried out only when de-energised.

The appliance should be commissioned by qualified professionals only.

Make sure to adhere to valid safety regulations.

Any repairs or maintenance within the warranty period should be carried out only by approved service engineers confirmed by Electrorad UK Ltd.

For the correct installation of radiators it is essential that the fixing of the radiator is carried out in such a way that it is suitable for intended use AND predictable misuse. A number of elements need to be taken into consideration including the fixing method used to secure the radiator to the wall, the type and condition of the wall itself, and any additional potential forces or weights, prior to finalising installation. **IN ALL CASES IT IS STRONGLY RECOMMENDED THAT A SUITABLY QUALIFIED PROFESSIONAL INSTALLER OR SIMILAR TRADESPERSON CARRIES OUT THE INSTALLATION.**

PLEASE NOTE: The fixing materials provided are only intended for installation on walls made of solid wood, bricks, concrete or on timber-frame stud walls where the fixing is into the timber. All walls being considered should have no more than a maximum of 3mm wall finishing. For walls made of other materials, for example hollow bricks, please consult your installer and/or specialist supplier. **ONCE AGAIN, IF YOU ARE UNSURE, IT IS STRONGLY RECOMMENDED THAT A SUITABLY QUALIFIED PROFESSIONAL INSTALLER OR SIMILAR TRADESPERSON CARRIES OUT THE INSTALLATION.**

The radiator is equipped with an overheat protection that cannot be reset (melt fuse). This overheat protection disconnects the current if the radiator becomes too hot (e.g. when covered).

If the supply cord is damaged, it must be replaced by the manufacturer, his service agent or similar qualified persons in order to avoid a hazard.

1.0 Warnings & Safety Information (cont...)

The radiator is filled with an exact amount of environmental friendly vegetable oil. Any repairs that require the radiator to be opened shall therefore only be carried out by the

manufacturer or his approved agent. Please contact Electrorad UK Ltd in case of leakage.

2.0 General Information

- The appliance is a sealed electric radiator designed for fixed wall mounted installation.
- The radiator conforms to the standards EN 60335-1 and EN 60335-2-30.
- The radiator is class 1 and splash resistant (IP44).
- The radiator complies with the European Directive 2014/30/EU (CE Marking on all radiators).
- The radiator is supplied complete with power cable* and wall brackets.

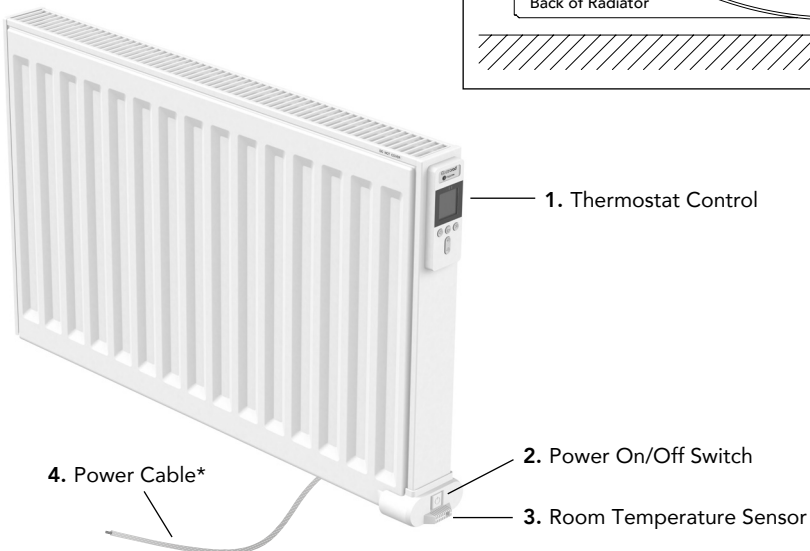
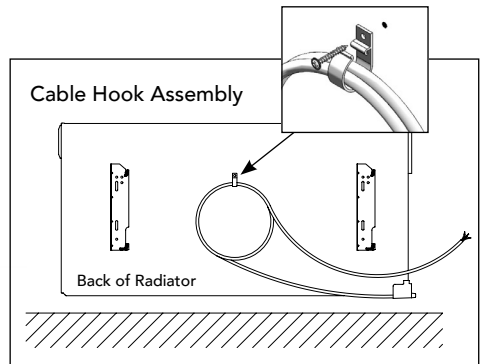

3.0 Installation

POSITIONING

- The radiator must be positioned horizontally, the right way up on the wall in order for it to function correctly. Never switch the radiator on in any other position as this will damage the electrical element(s).
- The radiator must be positioned according to the applicable standards and the minimum distances as specified in figure 1 should be carefully observed.
- The radiator must not be located underneath an electric socket.

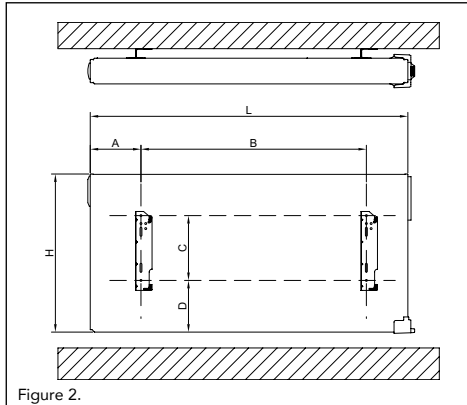

Figure 2.

- This product is splash resistant with an IP44 rating. This must be considered when installing in a location containing a bath or shower, as defined by BS 7671.
- The radiator may be positioned in zone 2 (figure 4) of the bathroom, in so far as no operating controls (button, switch, etc.) are in reach of persons in the bath or under the shower.

FIXING

- Mark out the distance between the brackets and the positions for the screw holes as shown in figure 2 and the dimension tables at the top of page 7, and ensure the safety clips are used (see figure 3).

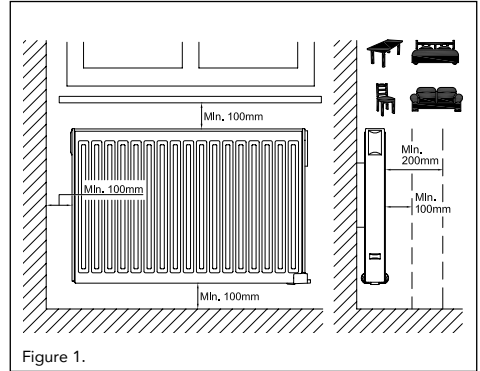

Figure 1.

Safety Clip-on Brackets

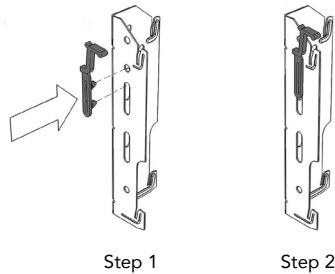

Figure 3.

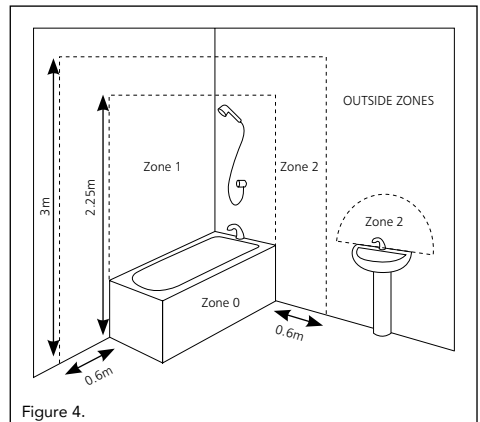

Figure 4.

3.0 Installation (cont...)

Electrorad Digi-Line Single Panel (refer to figure 2)

Height (mm)	300	500	Length (mm)	400	550	800	1050	1100	1300	1500
C	135	205	A (min)	135	135	135	135	135	135	135
D	90	163	A (max)	160	160	160	160	160	160	160
			B (min)	101	254	508	762	812	1016	1219
			B (max)	152	305	558	812	863	1066	1270

Electrorad Digi-Line Double Panel (refer to figure 2)

Height (mm)	300	500								
C	135	205								
D	90	163								
Length (mm)	400	500	650	800	950	1000	1250	1300	1600	2000
A	160	160	160	160	160	160	160	160	160	160
B	101	203	355	508	660	711	965	1016	1320	1727

CONNECTION

- The electrical installation must comply with the local or national regulations.
- The radiator must be connected to the electrical supply, using a switched fused spur with 3mm separation on all poles.
- If the radiator is installed in a bathroom or shower room, it must be protected with a residual current device (RCD) with a rated residual current not exceeding 30 mA.

4.0 Maintenance, Repair & Disposal

- Use only a damp cloth for cleaning and wiping of the radiator which should be switched off at this time.
- When scrapping the radiator, follow the regulations concerning the disposal of oil.

5.0 Waste Disposal According to The WEEE Directive (2012/19/EU)



Waste disposal according to the WEEE Directive (2012/19/EU). The symbol on the product label indicates that the product may not be handled as domestic waste, but must be sorted separately. When it reaches the end of its useful life, it shall be returned to a collection facility for electrical and electronic products. By returning the product, you will help to prevent possible

negative effects on the environment and health to which the product can contribute if it is disposed of as ordinary domestic waste. For information about recycling and collection facilities, you should contact your local authority/municipality or refuse collection service or the business from which you purchased the product. Applicable to countries where this Directive has been adopted.

6.0 Warranty

The product is covered by a 10 year warranty except for the electrical and electronic components that are covered by a 2 year warranty. You can register your warranty here: www.electrorad.co.uk/warranty-registration



7.0 Operating Instructions

The electronic thermostat has an LCD display specially designed for the regulation of the electric radiator. It will optimise energy consumption and increase comfort levels.

Features:

- Display with backlight
- Wireless Zigbee 3.0 programmer options (see separate instructions)

7.1 Display

1. Programme information bar or "behaviour" indicator.
2. Day of week indicator.
3. Cloud icon (with Unisenza+ Gateway).
4. "RF connection" indicator (with Unisenza+ Gateway).
5. Adaptive Start indicator.
6. "Room temperature" indicator.
7. Operating mode menu.
8. "Open Window" function indicator.
9. Master/Follower indicator (with Unisenza+ Gateway).
10. Warning indicator.
11. Installation parameter indicator.
12. Parameters number when icon "11" is displayed.
13. Front panel temperature limit indicator.
14. Heating demand indicator.
15. Pilot wire indicator.
16. Display zone for temperatures or time.
17. Hand icon.
18. "Key lock" function indicator.

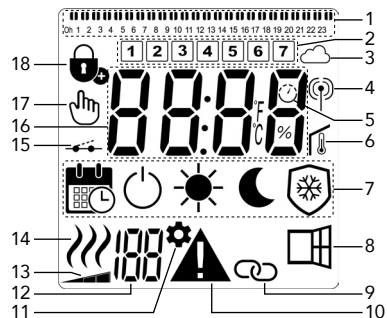

7.2 Behaviour Indicator



These are the coloured indicators above the LCD display that gives a visual indication of how much energy the current temperature setting is using i.e.

- red = high
- orange = medium
- green = low energy consumption

As you increase the temperature setting, the behaviour indicator segments in section 1 of the LCD display, will appear under the orange or red indicators.

The opposite applies when decreasing the temperature setting.

NOTE: The behaviour indicator segments are replaced by the program information bar when in Program mode. You can only view the behaviour indicator when in Comfort mode.

7.3 Keypad



Keys:

- < = Left Navigation Key
- > = Right Navigation Key
- + = Plus Key
- = Minus Key
- OK = Validation Key

8.0 Working Mode Definition



How to change between the operating modes:

In basic mode, only Comfort and Programme mode are available.

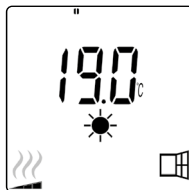

How to change comfort and programme mode temperatures:

- Press any button to turn on the backlight.
 - By pressing the "+" or "-" buttons, the set temperature will start to blink and can be adjusted to the desired temperature level.
 - Wait 6 seconds until the new set temperature stops blinking or press the "OK" button to confirm immediately.
- Press any button to turn on the backlight.
 - Press the "◀" or "▶" buttons to enable scrolling between modes.
 - Use the left "◀" or right "▶" buttons to move to the desired operating mode and press "OK" to confirm your choice.



8.0 Working Mode Definition (cont...)

How to view the measured room temperature:



- Press the "OK" button twice. On the first press, the screen will illuminate, and on the second press, the measured room temperature will be displayed together with the room temperature icon , in section 6 of the LCD display.
- The display will return automatically to the active operation mode after 8 seconds.

8.1 Heating

When the radiator is heating, the , in section 14 of the LCD display, is constantly displayed. As the radiator regulates, the  may not always be displayed due to the required heating demand.

8.2 Advanced Mode

To gain access to all operating modes, please refer to section 9.0, and set parameter number 01 to "YES".

8.3 Stand Alone Radiator

COMFORT MODE

This mode is to be used during periods of normal occupancy.

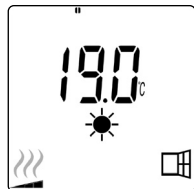

- Default value: 19.0°C

REDUCED MODE (Advanced mode only)

This mode is to be used at night-time or when the house is unoccupied for a few hours or more.



- Default value: 15.5°C

PROGRAMME MODE

NOTE: By default, the product will follow the commands of an external programmer when set in this mode. Programme d1 must be selected (default).

To enable the product to follow the internal clock, please refer to section 9.0, setting parameter number 10 to "YES" to set the time, and selecting a heating programme in parameter number 11.

When you return to the main screen, the selected programme and time settings will now be displayed.

To select a heating programme, please refer to section 9.0, and select parameter number 11 to view the available heating programmes.



- Default value: 19.0°C

NOTE: If connected to a gateway, it is not possible to set the time.

8.3 Stand Alone Radiator (cont...)

ANTI-FREEZE MODE

(Advanced mode only)

This mode is to be used when the house is unoccupied for extended periods of time.



- Default value: 7.0°C

STANDBY MODE (Advanced mode only)

In this mode the radiator is switched off and the word "OFF" will be shown on the LCD display.

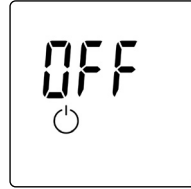

- The radiator will no longer receive signals from a wired external programmer.
- At any time you can check the measured room temperature by pressing the "OK" button.

ATTENTION: Please be aware, if there is no heating in your property then your pipes could freeze. For the protection of product and property in very low temperatures we recommend the "Anti-Freeze" mode is used.

ATTENTION: In this mode the radiators are still connected to the electrical supply.

8.4 Radiator Connected to a Unisenza Plus Gateway

WIRELESS RADIO INITIALIZATION (PAIRING)

Simultaneously press and hold the "◀" and "▶" keys for 8 seconds until (attached image file "Symbol - Gear 01"), in section 11 of the LCD display, and "rF" are displayed on the screen.

Press "OK" to enter this initialization sequence. The digits will cycle showing that the digital

thermostat is waiting for a radio link signal from the gateway to be received (press "<" to cancel radio initialization). When the radio link signal is received, pairing is saved, then it will return to the main screen, but now the cloud and antenna symbols will be displayed.

8.5 Key Lock Function

KEY LOCK FUNCTION

Use the Key Lock function to prevent any changes to your settings (in a child's room, public area... etc).

- To activate the Key Lock function, simultaneously press and hold the "◀", "OK", and "▶" buttons for 10 seconds.
- The key lock  icon, in section 18 of the LCD display, will be displayed on the screen.

- Repeat the same procedure to unlock the keypad. This function is available in all operating modes.

NOTE: When connected to the Unisenza PLUS Gateway, the product can only be locked and unlocked in the App.

8.5 Key Lock Function (cont...)

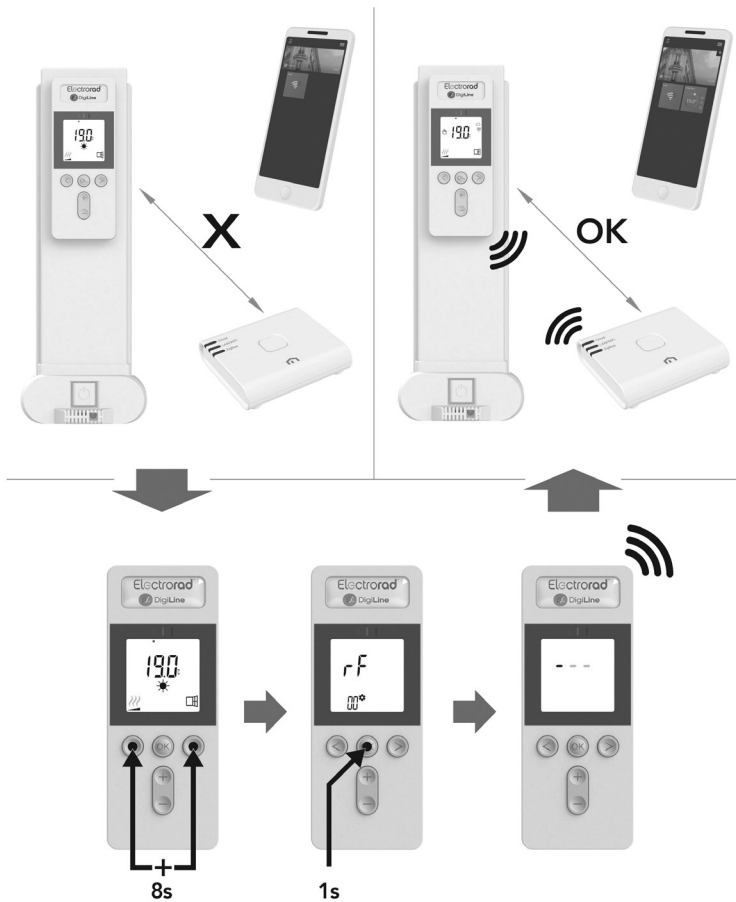

9.0 Parameter Menu

The thermostat has a parameter menu. In order to enter this menu, simultaneously press and hold the "◀" and "▶" keys for 8 seconds until , in section 11 of the LCD display, and "rF" is displayed on the screen.

Parameters can be selected using the left "◀" and right "▶" navigation buttons.





Once the required parameter is displayed, press the "OK" button. Modify the parameter settings with the "+" or "-" buttons and confirm your adjustment with the "OK" button.

To exit the parameter menu, choose the parameter "END" and press the "OK" button.



9.0 Parameter Menu (cont...)

N°	Default value & other possibilities
00	<p>rF: Wireless Radio initialisation (pairing) Press "OK" to enter this initialisation sequence. The digits will cycle showing that the digital thermostat is waiting for a radio link signal from the gateway to be received (press "◀" to cancel radio initialization). When the radio link signal is received, pairing is saved, then it will return to the main screen, but now the cloud and antenna symbols will be displayed.</p>
01	<p>ALL: Expert Setting Press "OK" to enter this parameter. Select with "+" or "-" and confirm by pressing the "OK" button: no: Basic mode (only Programme and Comfort modes available). YES: Advanced mode (all modes available). NOTE: If connected to a Unisenza+ Gateway, this setting will only be available in the App.</p>
02	<p>dEg: Type of Degrees Displayed Press "OK" to enter this parameter. Select with "+" or "-" and confirm by pressing the "OK" button: °C = Celsius °F = Fahrenheit NOTE: If connected to a Unisenza+ Gateway, this setting will only be available in the App.</p>
03	<p>___ : Calibration of the Internal Probe The calibration must be done after 1 day working with the same setting temperature in accordance with the following description: Put a thermometer in the room at 1.5m distance from the floor (like the thermostat) and check the real temperature in the room after 1 hour. When you enter the calibration parameter screen the actual temperature value is displayed. To enter the value shown on the thermometer, use the "-" or "+" buttons to enter the real value. At this point the hand icon, in section 17 of the LCD display, will be displayed and the value will blink. Press the "OK" key to confirm and save. If you need to erase a calibration already saved use the "-" or "+" buttons to alter the value, even just by 0.5°C, then press the left "◀" navigation button. The hand symbol will disappear and the factory calibrated temperature reading will be displayed. NOTE: Only the heating elements (including follower radiators) managed by the thermostat must be used during the calibration process. Do not have a secondary heat source in the same room for a period of 24 hours before hand. NOTE: If connected to a Unisenza+ Gateway, this setting will only be available in the App.</p>

9.0 Parameter Menu (cont...)

N°	Default value & other possibilities																
04	<p>SurF: Front Panel Temperature Limitation </p> <p>This power setting can be used to limit the output of the heating element in the front panel and as a consequence will limit the surface temperature of the front panel. Press "OK" to enter this parameter. Select with "+" or "-" and confirm by pressing the "OK" button:</p> <p>no = 100% (default). Mid = 70% Lo = 55%</p> <p>NOTE: If connected to a Unisenza+ Gateway, this setting will only be available in the App. NOTE: When considering the permanent use of the radiator at 60°C or 75°C maximum, the following correction factor should be applied for the output.</p> <table border="1"> <thead> <tr> <th>Setting</th> <th>Surface Temperature</th> <th>Single Panel</th> <th>Double Panel</th> </tr> </thead> <tbody> <tr> <td>no</td> <td>~ 90°C max</td> <td>1</td> <td>1</td> </tr> <tr> <td>Mid</td> <td>~ 75°C max</td> <td>~ 0.70</td> <td>~ 0.90</td> </tr> <tr> <td>Lo</td> <td>~ 60°C max</td> <td>~ 0.55</td> <td>~ 0.80</td> </tr> </tbody> </table> <p>E.g. A 1000 Watt single panel programmed for a maximum surface temperature of 75°C will deliver maximum 700 Watts. A 1000 Watt double panel programmed for a maximum surface temperature of 60°C will deliver maximum 800 Watts. These values should be considered when selecting the number and type of panels to cover the calculated heat losses.</p>	Setting	Surface Temperature	Single Panel	Double Panel	no	~ 90°C max	1	1	Mid	~ 75°C max	~ 0.70	~ 0.90	Lo	~ 60°C max	~ 0.55	~ 0.80
Setting	Surface Temperature	Single Panel	Double Panel														
no	~ 90°C max	1	1														
Mid	~ 75°C max	~ 0.70	~ 0.90														
Lo	~ 60°C max	~ 0.55	~ 0.80														
05	<p>Firmware Version</p> <p>Displays the MCU and ZigBee firmware alternately every 2 seconds.</p>																
06	<p>Wind: Open Window Detection  (the text "Wind" is displayed)</p> <p>Press the "OK" key to enter this parameter. Select with "+" or "-" and confirm by pressing the "OK" key:</p> <p>no: open window detection function disabled. YES: open window detection function enabled (default). The , in section 8 of the LCD display, is constantly displayed.</p> <p>This function will switch the radiator from any active mode to "Frost Protection" mode when an open window is detected (room temperature drops within a certain time). The open window icon  will start to blink, and continue to blink as long as the function is active.</p> <p>To return to the previous or automatic mode, press the "OK" key twice.</p> <p>NOTE: If connected to a Unisenza+ Gateway, this setting will only be available in the App.</p>																

9.0 Parameter Menu (cont...)

N°	Default value & other possibilities
07	<p>ItCS: Adaptive Start</p> <p>Press the "OK" key to enter this parameter. Select with "+" or "-" and confirm by pressing the "OK" key:</p> <p>no: adaptive start function disabled. Heating up to reach the Comfort set temperature will start at the programmed time.</p> <p>YES: adaptive start function enabled (default).</p> <p>Heating up will start at the predicted optimal time to reach the Comfort set temperature at the programmed time.</p> <p>The  , in section 5 of the LCD display, is constantly displayed (programme mode only). The adaptive start icon  will blink when pre-heating commences.</p> <p>NOTE: Heating start times will vary for each heating period when this function is enabled.</p> <p>NOTE: If connected to a Unisenza+ Gateway, this setting will only be available in the App.</p>
08	<p>SLA or FOLL: (NOT USED)</p> <p>Factory set to "no" and must not be altered.</p> <p>NOTE: If connected to a Unisenza+ Gateway, this setting will only be available in the App.</p>
09	<p>CLr: Factory Setting</p> <p>Press and hold the "OK" key for 6 seconds to reset Set point temperatures and all user parameters in this menu to factory default settings.</p> <p>NOTE: Pairing with the Unisenza+ Gateway will be lost.</p> <p>The screen will go blank, the LCD screen will illuminate and all segments will be displayed for a few seconds, before displaying the software version. The "Comfort" mode screen will then appear.</p>
10	<p>hour: Time Setting</p> <p>NOTE: If power is lost, from a power cut or the product is switched off, even just for a few seconds, the time and day setting will be lost.</p> <p>NOTE: If connected to a Unisenza+ Gateway, this setting will only be available in the App.</p> <p>no: time setting disabled (default).</p> <p>YES: time setting enabled.</p> <ul style="list-style-type: none"> ● The hour value will blink. Adjust the hour value by pressing the "+" or "-" keys, then confirm by pressing the "OK" key. ● The minute value will blink. Adjust the minute value by pressing the "+" or "-" keys, then confirm by pressing the "OK" key. ● The day values, in section 2 of the LCD display, will blink. Adjust the day value by pressing the "+" or "-" keys, then confirm by pressing the "OK" key. ● The "Comfort" mode or previously selected operating mode screen will appear.

9.0 Parameter Menu (cont...)

N° Default value & other possibilities

11 11 prog: Select/Define Heating Programme

NOTE: If connected to a Unisenza+ Gateway, this setting will only be available in the App.

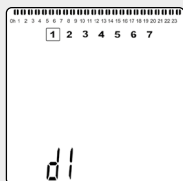
SELECTING A PROGRAMME

- Use the "+" or "-" keys to select one of the preset programmes, d1 to d9 (section 14.0), or one of the user definable programmes, U1 to U4. The programme number will blink. The heating schedule for the current day is displayed along the top of the LCD screen.
- To view the heating schedule for the other days, press the "◀" or "▶" keys. Press the "OK" key to confirm the programme to be followed.

DEFINING A USER PROGRAMME

NOTE: Once saved, the user defined programmes are not lost in the event of a power cut. However, the time will reset to 00:00 and day 1 when the power returns, if not set, so the product may not heat at the expected times.

NOTE: If a user defined programme has already been created and saved, it will be overwritten when the newly defined user programme is saved.

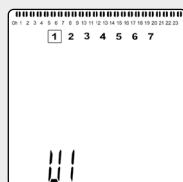

- Use the "+" or "-" keys to select a user definable programme, U1 to U4, to be modified, then press and hold the "OK" key for 3 seconds.



- The left screen will be shown, where the ☾ symbol, the time value 00:00, and the time segment in the programme information bar along the bottom of the screen will blink continuously.



- Use the "+" or "-" keys to adjust the time at which the first Reduced period will end.
- As the time indexes, the blinking segment on the programme information bar will move horizontally along the time scale according to the time value.

9.0 Parameter Menu (cont...)

N° Default value & other possibilities

11 prog: Select/Define Heating Programme (cont...)



- Press the "OK" key to confirm the time at which the mode will change over from Reduced to Comfort. The ☀ symbol will start to blink instead of the ☾ symbol, signifying the start of this Comfort period.



- Use the "+" and "-" keys to adjust the time at which the first Comfort period will end. The segments in the programme information bar will populate to show the Comfort period.



- Press the "OK" key to confirm the time at which the mode will change over from Comfort to Reduced. The ☾ symbol will start to blink instead of the ☀ symbol, signifying the start of this Reduced period.



- Use the "+" and "-" keys to adjust the time at which this Reduced period will end.



- Press the "OK" key to confirm the time at which the mode will change over from Reduced to Comfort. The ☀ symbol will start to blink instead of the ☾ symbol, signifying the start of this Comfort period.



- Use the "+" and "-" keys to adjust the time at which this Reduced period will end. The segments in the programme information bar will populate to show the Comfort period.

9.0 Parameter Menu (cont...)

N° Default value & other possibilities

11 prog: Select/Define Heating Programme (cont...)



- Press the "OK" key to confirm the time at which the mode will change over from Comfort to Reduced. The ☾ symbol will start to blink instead of the ☀ symbol, signifying the start of this Reduced period.
- If more than two Comfort periods are required, repeat the previous steps.



- When all Comfort periods have been defined, use the "+" key to advance beyond the time "23:30". The above screen will then be shown, asking if the programme that has just been defined for that day is to be copied to the next day.
- To copy the programme onto the next day, press the "OK" key. Press the "OK" key for any further days the programme is to be copied over to.

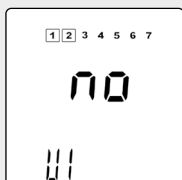

- If a different programme is to be defined for the next day, press the "+" or "-" key until the word "no" is displayed. Press the "OK" key to confirm.



- The day number will increment to the next day and the time will be set back to "00:00".



- When all of the days have been defined, the word "SAVE" will be displayed. To save the programme, press the "OK" key to confirm.
- If the programme is not to be saved, so that any previously user defined programme is not overwritten, press the left "◀" arrow key. The screen will revert back to the Programme Selection screen.

9.0 Parameter Menu (cont...)

N°	Default value & other possibilities
13	<p>MAC: ZigBee Module Mac Address</p> <p>Press "OK" to enter this parameter. The 16 digits of the MAC address will be displayed, 4 digits at a time. Each of the 4 digits will be displayed for 3 seconds.</p>
14	<p>CodE: ZigBee Module Installation Code</p> <p>Press "OK" to enter this parameter. The 32 digits of the MAC address will be displayed, 4 digits at a time. Each of the 4 digits will be displayed for 3 seconds.</p>
15	RES: Not Used
19	<p>End: Exit the Parameter Menu</p> <p>Press the "OK" key to exit installation parameter menu and return to normal operation.</p>

10.0 Technical Characteristics

<p>Environmental:</p> <p>Operating temperature</p> <p>Shipping and storage temperature</p>	<p>-30°C - +50°C</p> <p>-30°C to +70°C</p>
Electrical protection	Class I - IP44
Impact protection	IK08
<p>Setting temperature range:</p> <p>Comfort</p> <p>Reduced</p> <p>Frost Protection</p>	<p>Between 5.5°C and 30°C, must be higher than reduced mode setting</p> <p>Between 5°C and 19°C, must be less than comfort mode setting</p> <p>Between 0.5°C and 10°C</p>
Power Supply	230Vac +/- 10% 50Hz
<p>Norms and directives:</p> <p>Your thermostat was designed in accordance with the following European norms and directives:</p>	<p>ECO Directive 2009/125/EC</p> <p>2014/35/EU - Low Voltage</p> <p>2014/30/EU - EMC</p> <p>EN60335-1 - Heaters</p> <p>2014/53/EU - RED</p> <p>2011/65/EU</p>

11.0 Troubleshooting & Solution

Q: My Thermostat doesn't work.

- A:**
- Check the power supply.
 - Contact your installer.

Q: My Thermostat shows an Error message "▲" blinks on the display.

- A:** The symbol "▲ +  " flashes.
Error detected on the internal sensor.
- Contact your installer or seller.

Q: My Thermostat seems to work correctly but the heating doesn't work correctly.

- A:**
- Is the radiator that is not heating up near an open window?
Check the settings in Parameter 06 (on page 14).
 - Contact your installer.

Q: My Thermostat seems to work correctly but the temperature in the room is not in accordance with the programme.

- A:**
- Check the Clock.
 - The difference between Comfort & Reduced temperature is too high.
 - Proceed with a calibration of internal probe (see parameter 03 on page 13).

Q: The front heating panel is cooler than the back panel.

- A:**
- Check the power settings as indicated in section 4 (on page 13).

12.0 Preset Programmes

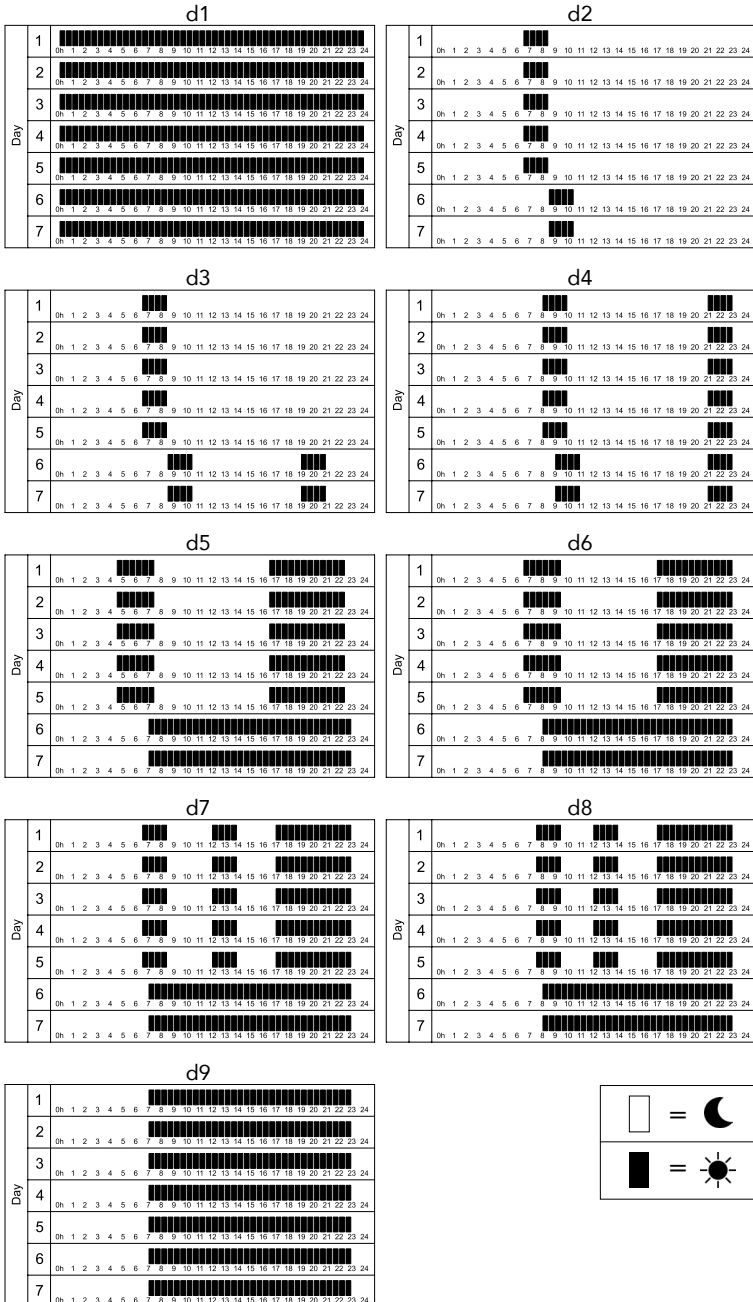

13.0 Eco Directive Characteristics

Model identifier(s): DE xxxxx Z where "x" may be any character.

Item	Symbol	Value	Unit
Heat Output			
Nominal heat output where "xxxxx" = 30SC40	P_{nom}	0.25	kW
Nominal heat output where "xxxxx" = 30SC80, 50SC55, 30DX50, or 50DX40	P_{nom}	0.50	kW
Nominal heat output where "xxxxx" = 30SC110, 50SC80, 30DX80, or 50DX50	P_{nom}	0.75	kW
Nominal heat output where "xxxxx" = 30SC150, 50SC105, 30DX100, or 50DX65	P_{nom}	1.00	kW
Nominal heat output where "xxxxx" = 50SC130, 30DX130, or 50DX80	P_{nom}	1.25	kW
Nominal heat output where "xxxxx" = 30DX160 or 50DX95	P_{nom}	1.50	kW
Nominal heat output where "xxxxx" = 30DX200 or 50DX125	P_{nom}	2.00	kW
Minimum heat output (indicative)	P_{min}	N.A.	kW
Maximum continuous heat output where "xxxxx" = 30SC40	$P_{max,c}$	0.25	kW
Maximum continuous heat output where "xxxxx" = 30SC80, 50SC55, 30DX50, or 50DX40	$P_{max,c}$	0.50	kW
Maximum continuous heat output where "xxxxx" = 30SC110, 50SC80, 30DX80, or 50DX50	$P_{max,c}$	0.75	kW
Maximum continuous heat output where "xxxxx" = 30SC150, 50SC105, 30DX100, or 50DX65	$P_{max,c}$	1.00	kW
Maximum continuous heat output where "xxxxx" = 50SC130, 30DX130, or 50DX80	$P_{max,c}$	1.25	kW
Maximum continuous heat output where "xxxxx" = 30DX160 or 50DX95	$P_{max,c}$	1.50	kW
Maximum continuous heat output where "xxxxx" = 30DX200 or 50DX125	$P_{max,c}$	2.00	kW
Auxiliary electricity consumption			
At nominal heat output	E_{lmax}	0.00	kW
At minimum heat output	E_{lmin}	N.A.	kW
In standby mode	E_{lSB}	<0.001	kW

13.0 Eco Directive Characteristics (cont...)

Item	Unit
Type of heat output, for electric storage local space heaters only	
Manual heat charge control with integrated thermostat	N.A.
Manual heat charge control with room and/or outdoor temperature feedback	N.A.
Electronic heat charge control with room and/or outdoor temperature feedback	N.A.
Fan assisted heat output	N.A.
Type of heat output/room temperature control	
Single stage heat output and no room temperature control	No
Two or more manual stages, no room temperature control	No
With mechanic thermostat room temperature control	No
With electronic room temperature control	No
Electronic room temperature control plus day timer	No
Electronic room temperature control plus week timer	Yes
Other control options	
Room temperature control, with presence detection	No
Room temperature control, with open window detection	Yes
With distance control	Yes
With adaptive start control	Yes
With working time limitation	No
With black bulb sensor	No



ELECTRORAD UK LTD

5-7 Railsfield Rise, Bramley Business Park, Leeds, LS13 3SA

T: 0113 274 6799, sales@electrorad.co.uk, www.electrorad.co.uk

Register your product warranty here:

www.electrorad.co.uk/warranty-registration

After Sales Service:

ELECTRORAD UK LTD

T: 0113 274 6799, sales@electrorad.co.uk